

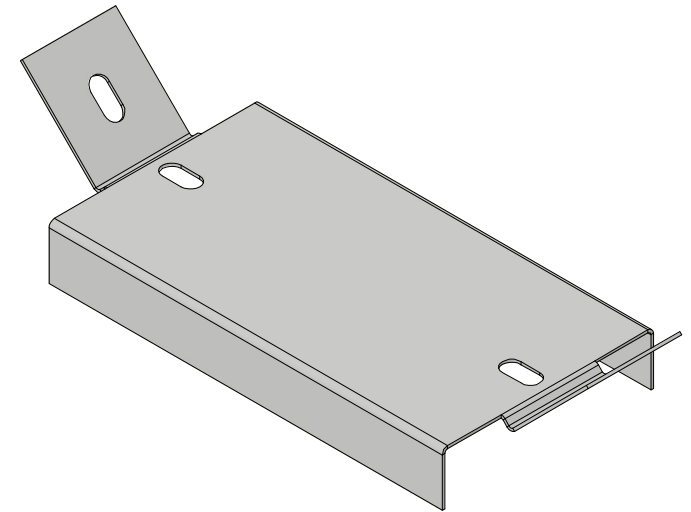

R.150

75



Designed:	Checked:	Approved:	Material: <Material>	Date 14/03/2023
			COVER OUTSIDE 90°	
			CAS90075020R150	Revision Sheet 1 / 1