

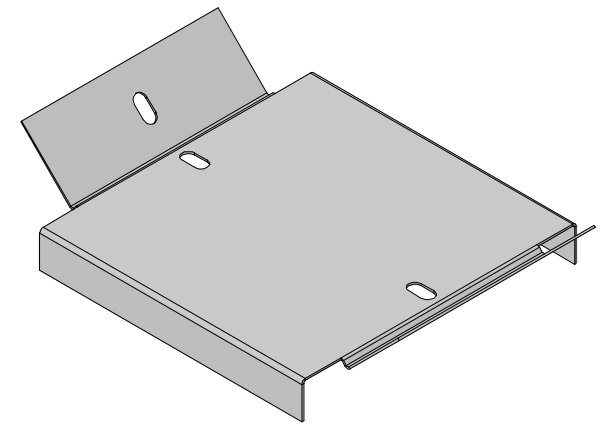

R.150

150



Designed:	Checked:	Approved:	Material: <Material>	Date 14/03/2023
		COVER OUTSIDE 90°		
		CAS90150020R150	Revision	Sheet 1 / 1